



PLASMA CUTTING









PLASMA CB 70



CE EN60974-7



CODE	↔	⏏
PA1270	6 m	19.7'
		
		1/8 GAS
PA1272	6 m	19.7'
		
		CENTRAL

TECHNICAL DATA		
 HF		
 1m	0,6 kg	1.43 lb
 V PEAK	500	
 5 bar		
 170 l/min		
 X 60%	70A	
 X 100%	50A	
 18-24 mm		

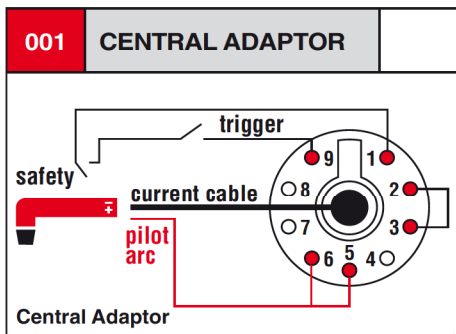
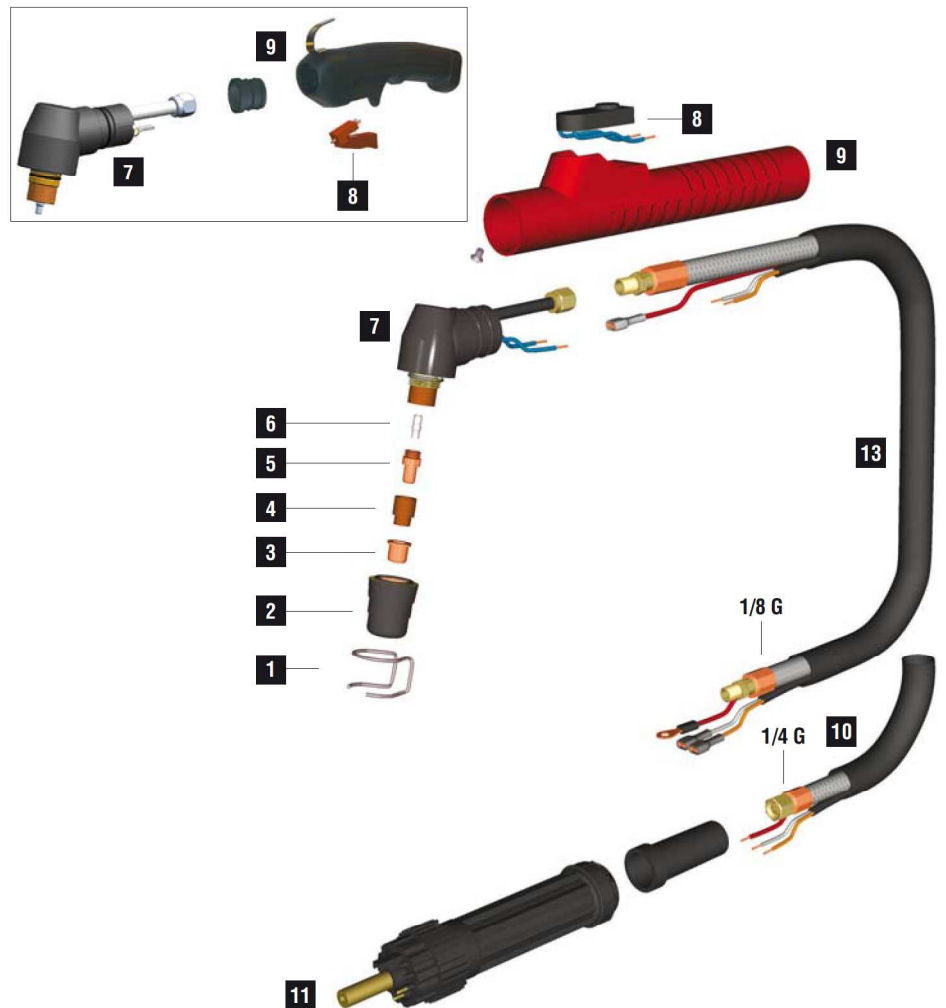

	CODE		Description	Ø	↔	CONTACT				DRAG		GOUGING	REF	
1	CV0010		plasma stand off guide		18,5 mm								743.0149 0618	10
1	CV0073		plasma stand off guide	24,2 mm	31 mm									1
1	CV1117		plasma stand off guide		26 mm								1405	2
2	PC0032				31,5 mm								5710171	2
3	PD0063-10		50 A	1,0 mm	.040"	26,8 mm								10
3	PD0063-11		60 A	1,1 mm	.043"	26,8 mm								10
3	PD0063-12		70 A	1,2 mm	.045"	26,8 mm								10
3	PD0085-98		50 A	0,98 mm	.038"	26,2 mm							1366	10
3	PD0088-06		20 A	0,65 mm	.025"	12,3 mm								10
3	PD0088-08		40 A	0,8 mm	.030"	12,3 mm								10
3	PD0088-10		50 A	1,0 mm	.040"	12,3 mm							1396	10
3	PD0088-11		60 A	1,1 mm	.043"	12,3 mm								10
3	PD0088-12		70 A	1,2 mm	.045"	12,3 mm							1308	10
4	PE0007			plasma diffuser										20101
5	CV0081													1
5	PR0063		plasma electrode		17,8 mm								1402	10
5	PR0064		plasma electrode		34,8 mm								1403	10
6	FH0211													
6	FH0215													

	CODE		Description	
7	EA0221			10
7	PF0030		plasma torch head Ø 28	1
7	PF1020		plasma torch head Ø 24	1
8	BX0020		trigger for TP0076	10
8	BX0070		trigger for TP0088	10
9	BW0342		Ø 24 - Ø 28	1
9	TP0076		handle kit	1
9	TP0088		handle kit	1

	CODE		Description	
10	PH0170		6 m - 1/4 G	1
10	PH0207		power cable 6 m - 1/4 G	1
10	QB0097		cover (mt)	100
11	CY0002		cable support	1
11	FY0014		central adaptor	1
13	PH0160		power cable 6 m - 1/8 G	1
13	PH0172		6 m - 1/8 G	1

STANDARD

CONTACT SHORT

CONTACT LONG

DRAG SHORT

DRAG LONG